

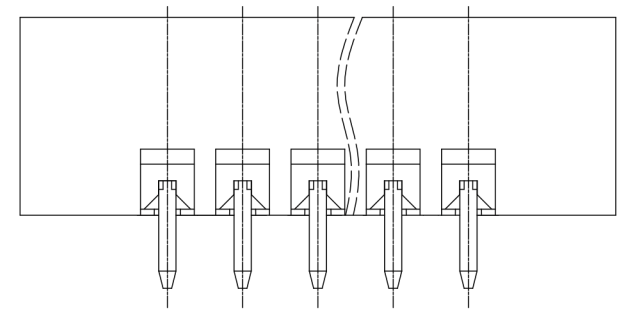

CELION[®]

REVISION RECORD

REV.	DESCRIPTION	ECN No.	APPROVED	DATE

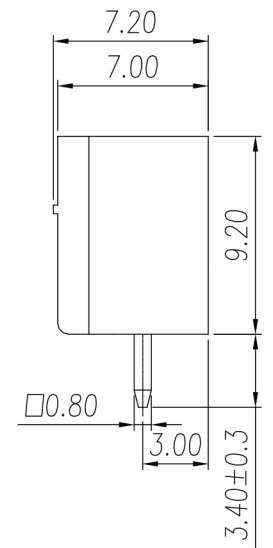
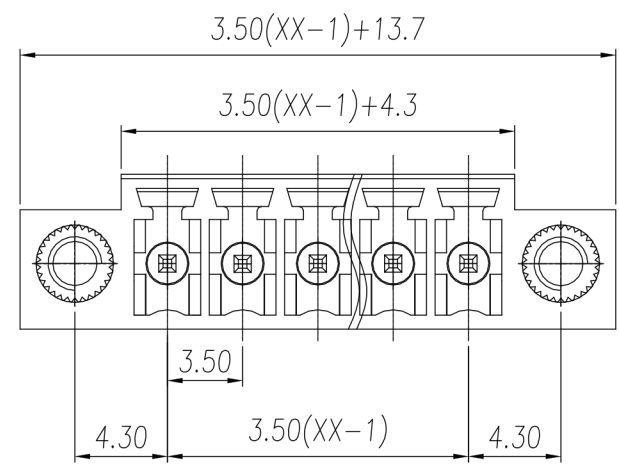
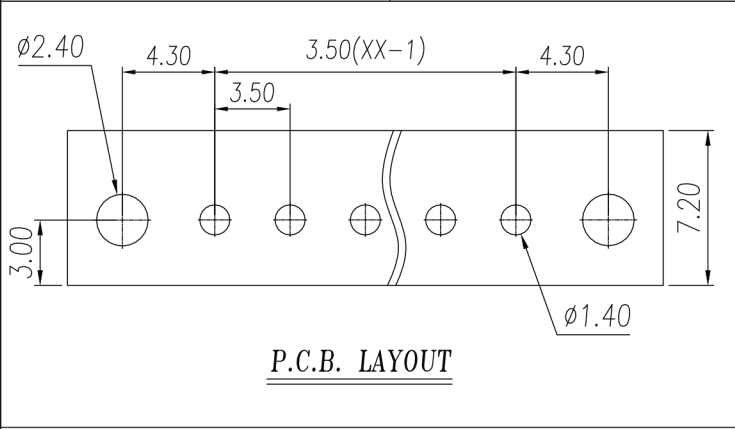

UL/CUL 技术参数				
UL/CUL Technical Data				
等级	Use Group	B	C	D
额定电压	Rated Voltage [V]	300	-	300
额定电流	Rated Current [A]	8	-	8
接线范围	Wire Range	-		
单/多芯线	Solid/Stranded [AWG]	-		
耐电压	Withstanding Voltage	1600V/1Min		
IEC 技术参数				
IEC Technical Data				
过电压类别	Overvoltage Category	III	III	II
污染等级	Contamination Class	3	2	2
额定电压	Rated Voltage [V]	160	160	250
额定电流	Rated Current [A]	7	7	7
额定冲击电压	Impulse withstand voltage [KV]	2.5	2.5	2.5
导线截面积	Conductor cross section	-		
硬质/柔性导线	Solid/flexible [mm ²]	-		
材料		Material		
绝缘材料	Insulation Material	PA66		
阻燃等级	Imflammability	UL94V-0		
导体材料	Contacting Material	铜合金 Copper alloy		
导体表面镀层	Contactive Coating	镀锡 Sn Plated		
一般参数		Other Data		
间距	Pitch / 极数 Poles [mm] / [P]	3.5 / 02~24		
剥线长度	Stripping Length [mm]	-		
螺丝	Screw/扭矩 Torque(Max) [N.m]	-		
工作温度	Operating temperature [°C]	-40~105		
焊锡温度	Soldering temperature	260°C/5S		
引针尺寸	Pin Dimensions [mm]	0.8*0.8		
PCB板孔径	PCB Hole Diameter [mm]	ø1.4		

linear dimension(Tolerances Standard GB/T 14486-2008)								—	∠	⊥
variable range	to 6	over 6 to 10	over 10 to 30	over 30 to 60	over 60 to 100	over 100 to 160	over 160 to	to 10	over 10 to 100	over 100 to
tolerance	±0.20	±0.30	±0.50	±0.70	±1.00	±1.30	±1.60	0.10	0.30	0.60

单位 / UNITS	mm	尺寸 / SIZE	A4	比例 / SCALE	3:1	第三视角 / THIRD ANGLE PROJECTION	版本 / REV	V0
							名称 / TITLE	15EDGVM-3.5-XXP-1YY-00A



CELION®

REVISION RECORD				
REV.	DESCRIPTION	ECN No.	APPROVED	DATE

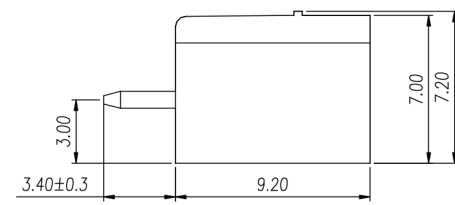
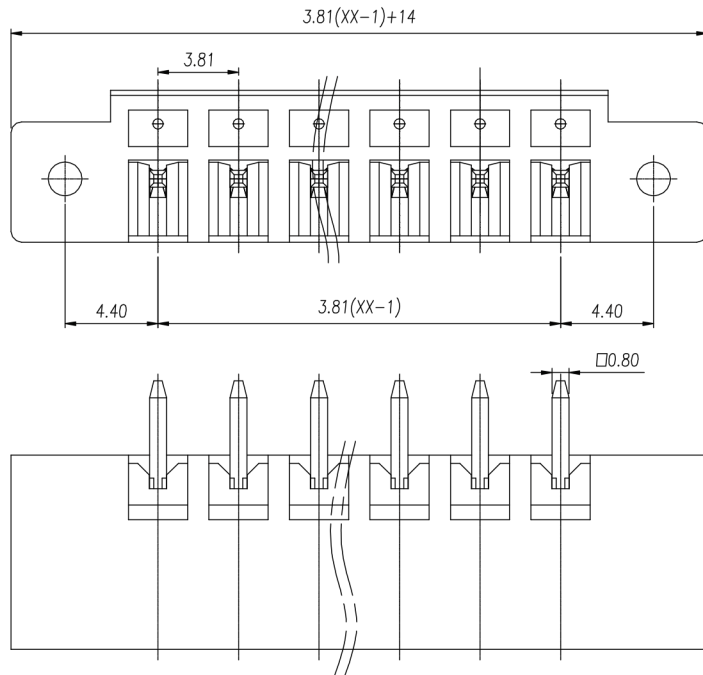
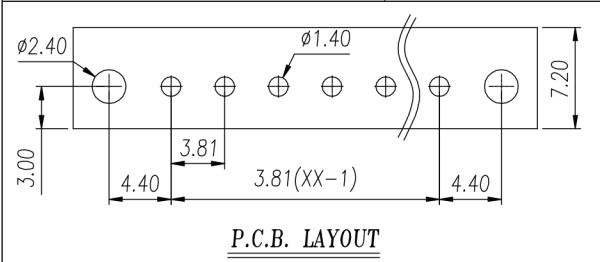

UL/CUL 技术参数				
UL/CUL Technical Data				
等级	Use Group	B	C	D
额定电压	Rated Voltage [V]	300	-	300
额定电流	Rated Current [A]	8	-	8
接线范围	Wire Range	-		
单/多芯线	Solid/Stranded [AWG]	-		
耐电压	Withstanding Voltage	1600V/1Min		
IEC 技术参数				
IEC Technical Data				
过电压类别	Overvoltage Category	III	III	II
污染等级	Contamination Class	3	2	2
额定电压	Rated Voltage [V]	160	160	250
额定电流	Rated Current [A]	7	7	7
额定冲击电压	Impulse withstand voltage [KV]	2.5	2.5	2.5
导线截面积	Conductor cross section	-		
硬质/柔性导线	Solid/flexible [mm ²]	-		
材料				
绝缘材料	Insulation Material	PA66		
阻燃等级	Imflamability	UL94V-0		
导体材料	Contacting Material	铜合金 Copper alloy		
导体表面镀层	Contactive Coating	镀锡 Sn Plated		
一般参数				
间距	Pitch / 极数 Poles [mm] / [P]	3.81 / 02-24		
剥线长度	Stripping Length [mm]	-		
螺丝	Screw/扭矩 Torque(Max) [N.m]	-		
工作温度	Operating temperature [°C]	-40~105		
锡焊温度	Soldering temperature	260°C/5S		
引针尺寸	Pin Dimensions [mm]	0.8*0.8		
PCB板孔径	PCB Hole Diameter [mm]	Ø1.4		

linear dimension(Tolerances Standard GB/T 14486-2008)										
variable range	to 6	over 6 to 10	over 10 to 30	over 30 to 60	over 60 to 100	over 100 to 160	over 160 to 10	over 10 to 100	over 100 to 100	
tolerance	±0.20	±0.30	±0.50	±0.70	±1.00	±1.30	±1.60	0.10	0.30	0.60

单位 / UNITS	mm	尺寸 / SIZE	A4	比例 / SCALE	3:1	第三视角 / THIRD ANGLE PROJECTION	版 / REV	V0
							名称 / TITLE 15EDGVM-3.81-XXP-1YY-00A	