

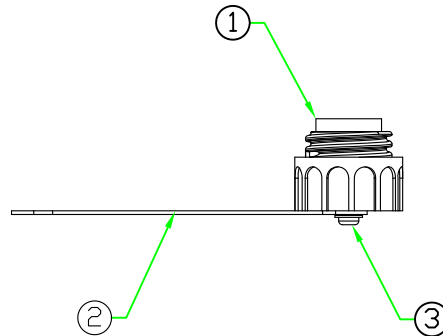

RoHS

REV.	DESCRIPTION	DATE
A	ISSUE	Jun/25/2014

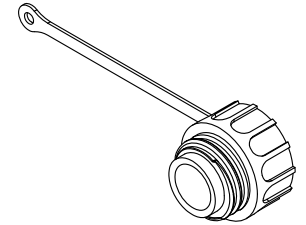
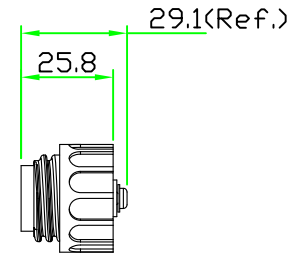
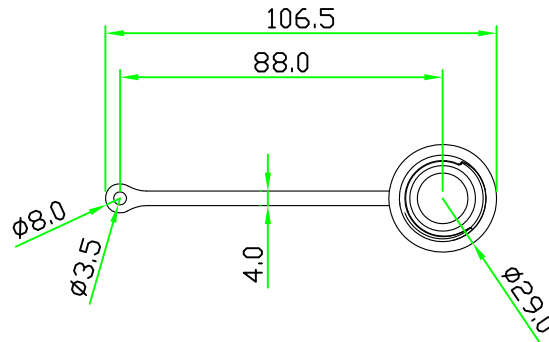
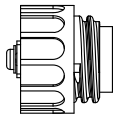
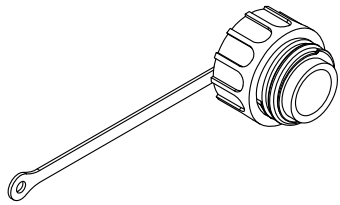

OLD P/N:CPA-F-WCAPC
(原型號)

No.	PART NAME	DESCRIPTION	COLOR	Q'TY	REMARKS
3	SCREW	M3 x 6mm Self-tap Screw.		1	
2	CHAIN	PU or TPE.	BLACK	1	
1	CAP	Waterproof Cap For Female, NYLON+GF.	BLACK	1	

	
	UNIT:mm SCALE 1:2
TITLE Waterproof Cap For CPP Female Connector	
P/N: CPP-WCAP-FC	
DWG.NO: CPP-WCAP-FC	
DR. Patty CH. ERIC AP.	
REV. A	SHEET 1/1

UNLESS OTHERWISE SPECIFIED TOLERANCES:
 .x ± 0.25 .xx ± 0.1
 .xxx ± 0.05 ANGLE ± 1°
 REV. SHEET