

REV.	DESCRIPTION	DATE
A	ISSUE	Dec/05/2013

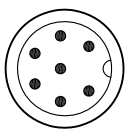

CPP-P104DSF CPP-P107DSF

RoHS

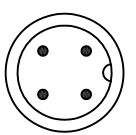
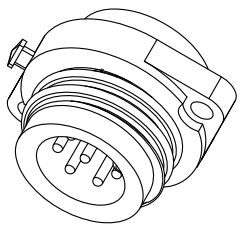
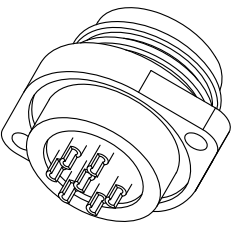
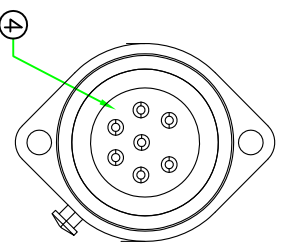
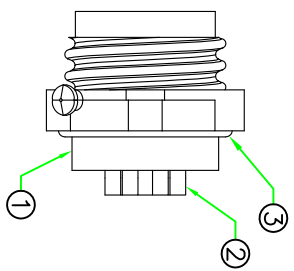
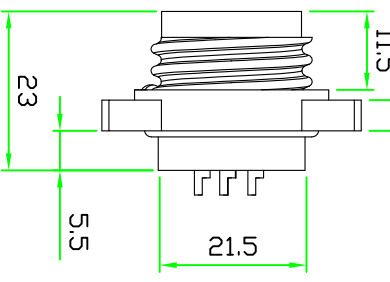
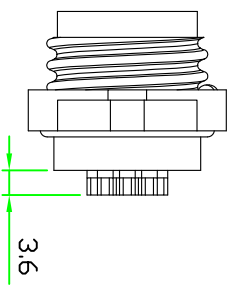
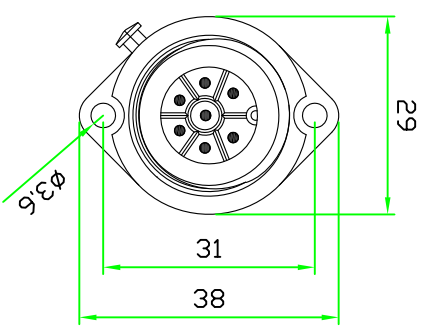
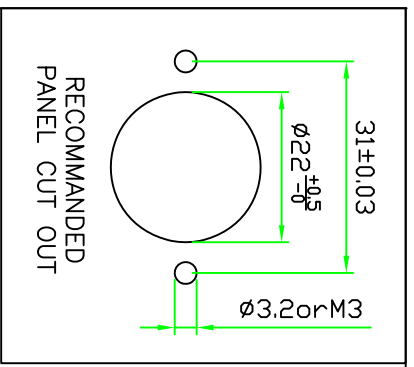
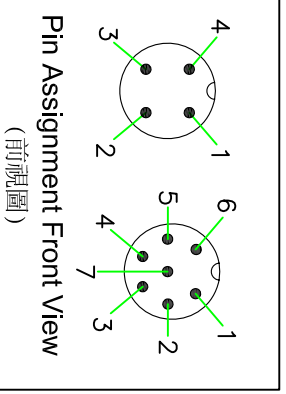

No.	PART NAME	DESCRIPTION	COLOR	Q'TY	REMARKS
3	GLUE	EPOXY.	BLACK	1	
3	O-RING	NBR.	BLACK	1	O-1620-EK
2	CONTACT	BRASS, MALE PIN, 6u" GOLD PLATED.		N	M1.5SPPL24.5
1	CONNECTOR	NYLON+GF.	BLACK	1	CPP-P11xxC (190-135)

		UNIT: mm	TITLE CIRCULAR P SIZE MALE SOLDER PIN SCREW TYPE ROUND FLANGE SCREW MOUNT PANEL CONNECTOR	
		SCALE 1:1	P/N: CPP-P1xxDSF	
<small>UNLESS OTHERWISE SPECIFIED TOLERANCES:</small> X ±0.25 XX ±0.1 XXX ±0.05 ANGLE ±1°		DR. JACK CH. MICHAEL		
REV. A	SHEET 1/1	DWG.NO: CPP-P1xxDSF		AP.

