

RECOMMENDED
PANEL CUT OUT

RoHS

IP67

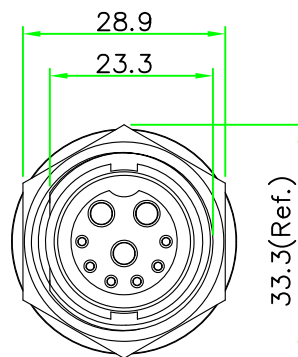
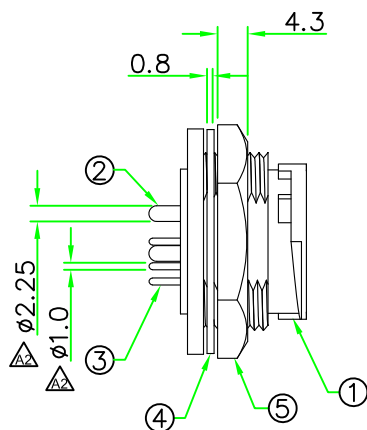
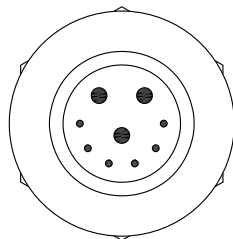
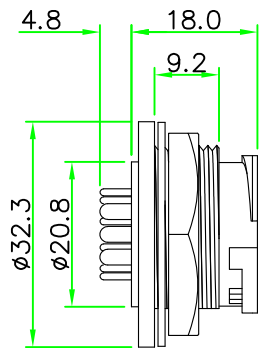

REV.	DESCRIPTION	DATE
A	ISSUE	Jul/24/2014
A1	Cancel P/N NO. CDGD-L333CPR-B & Change CDGD-L333CPR PIN ASSIGNMENT	Aug/01/2014
A2	Add PCB Pin dia..	Aug/06/2014
B	Modified pin assignment, title & Draw No.	Oct/14/2020

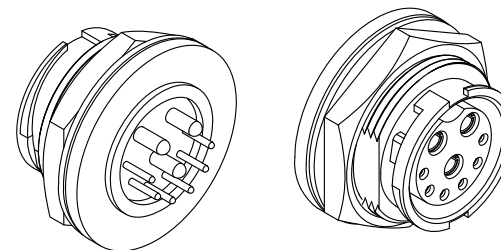

NOTES:

- ELECTRICAL CHARACTERISTICS:
CURRENT RATING: 20A + 5A
CONNECTOR TEMPERATURE RANGE: -25°C TO +85°C
DIELECTRIC WITHSTANDING VOLTAGE:
500V AC FOR ONE MINUTE
- Panel Thickness Max. : 3.5mm
- HOW TO ORDER: CDGD-L3xxCPR \triangle

- 2 - 2 PIN 5 - 5 PIN
- 3 - 3 PIN 6 - 6 PIN
- 4 - 4 PIN 7 - 7 PIN
- 2 - 2 PIN
- 3 - 3 PIN

※PIN ASSIGNMENT AND PCB LAYOUT SEE NEXT PAGE.

No.	PART NAME	DESCRIPTION	COLOR	Q'TY	REMARKS
5	HEX NUT	Nylon + GF.	BLACK	1	
4	GASKET	EPDM.	BLACK	1	
3	CONTACT	BRASS , 6 u" Gold Plated . Male Contact.		N	
2	CONTACT	BRASS , 6 u" Gold Plated . Male Contact.		N	
1	CONNECTOR	D Size Male Connector Insert.NYLON+GF.	BLACK	1	

		TITLE : Circular D Size Male Connector Female Pin Rear Mount Lock Type Round Flange With PCB Pin	
	UNIT: mm		SCALE 1:1
UNLESS OTHERWISE SPECIFIED TOLERANCES: .x ± 0.25 .xx ± 0.1 .xxx ± 0.05 ANGLE ± 1°		P/N: CDGD-L3xxCPR 	DR. SIBYL CH. JAMES
REV. B	SHEET 1/2	DWG.NO: CDGD-L3xxCPR 	AP.

REV.	DESCRIPTION	DATE
A	ISSUE	Jul/24/2014
A1	Cancel P/N NO. CDGD-L333CPR-B & Change CDGD-L333CPR PIN ASSIGNMENT	Aug/01/2014
A2	Add PCB Pin dia..	Aug/06/2014
B	Modified pin assignment, title & Draw No.	Oct/14/2020

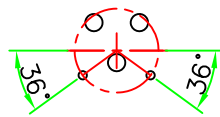
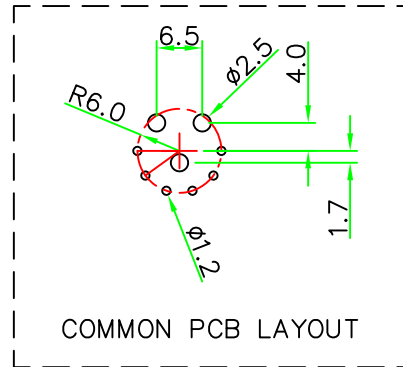

CDGD-L332CPR

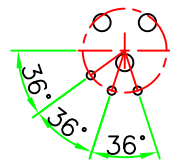

CDGD-L333CPR

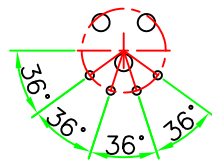

CDGD-L334CPR

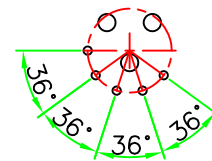

CDGD-L335CPR

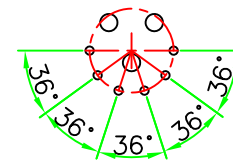

CDGD-L336CPR

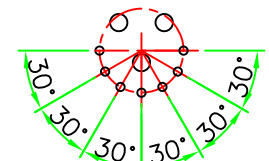

CDGD-L337CPR

PCB LAYOUT

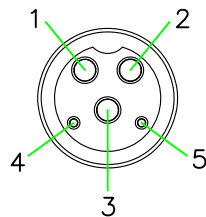

CDGD-L332CPR

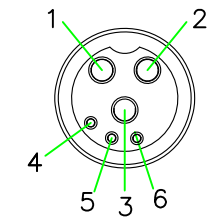

CDGD-L333CPR

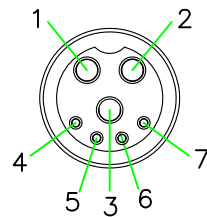

CDGD-L334CPR

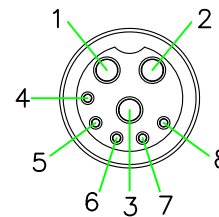

CDGD-L335CPR

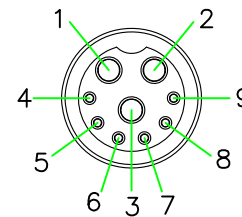

CDGD-L336CPR

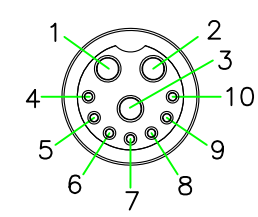

CDGD-L337CPR

PIN ASSIGNMENT FRONT VIEW

(前視圖)

HOLIN[®] HTP ASIA TECHNOLOGY CO., LTD. 禾凌科技股份有限公司		TITLE : Circular D Size Male Connector Female Pin Rear Mount Lock Type Round Flange With PCB Pin	
UNIT: mm	SCALE 1:1	P/N: CDGD-L3xxCPR	DR. SIBYL
UNLESS OTHERWISE SPECIFIED TOLERANCES: .X ± 0.25 .XX ± 0.1 .XXX ± 0.05 ANGLE ± 1°	REV. SHEET 1/2	DWG.NO: CDGD-L3xxCPR	CH. JAMES
			AP.