

RECOMMENDED
PANEL CUT OUT

RoHS

IP66~68

P/N No.	L	D
CBP	3.5	φ1.25
CBD	3.8	φ1.0
CBN	3.6	φ0.8

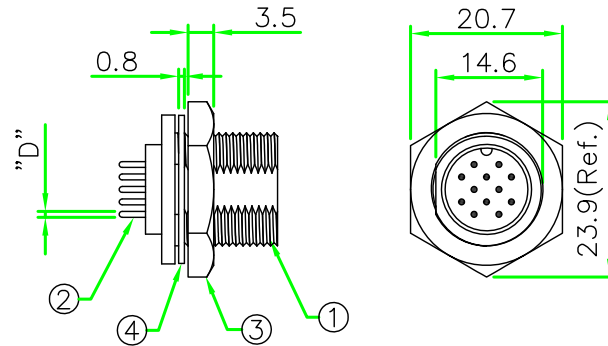
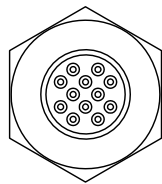
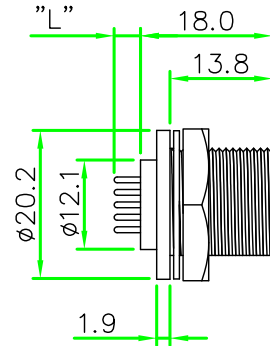

REV.	DESCRIPTION	DATE
A	ISSUE	Apr/15/2015

REF.

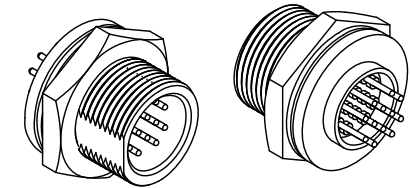

NOTES:

- ELECTRICAL CHARACTERISTICS:
CURRENT RATING: 2A / 5A / 10A
CONNECTOR TEMPERATURE RANGE: -25°C TO +85°C
DIELECTRIC WITHSTANDING VOLTAGE:
500V AC FOR ONE MINUTE
- PANEL THICKNESS MAX. 4.0mm
- HOW TO ORDER: CBx-P1xxCPR

- 02 - 2 PIN 07 - 7 PIN
- 03 - 3 PIN 08 - 8 PIN
- 04 - 4 PIN 10 - 10 PIN
- 05 - 5 PIN 12 - 12 PIN
- 06 - 6 PIN

- P - CURRENT RATING 10A
- D - CURRENT RATING 5A
- N - CURRENT RATING 2A

PIN ASSIGNMENT AND PCB LAYOUT SEE NEXT PAGE



	UNIT: mm	TITLE : Circular B Size Male Connector Male Pin Rear Mount Screw Type Round Flange PCB Pin
	SCALE 1:1	
UNLESS OTHERWISE SPECIFIED TOLERANCES: .x ± 0.5 .xx ± 0.25 .xxx ± 0.1 ANGLE ± 1°		P/N: CBx-P1xxCPR DWG.NO: CBx-P1xxCPR
REV. A	SHEET 1/2	

No.	PART NAME	DESCRIPTION	COLOR	Q'TY	REMARKS
4	HEX NUT	Nylon + GF.	BLACK	1	
3	GASKET	EPDM.	BLACK	1	
2	CONTACT	Brass , 6 u" Gold Plated . Male Contact.		N	
1	CONNECTOR	B Size Male Connector Insert.NYLON+GF.	BLACK	1	

REV.	DESCRIPTION	DATE
A	ISSUE	Apr/15/2015

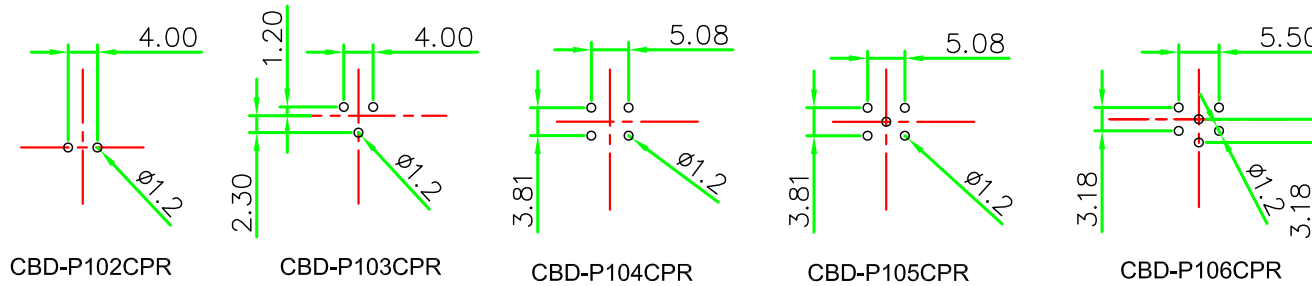
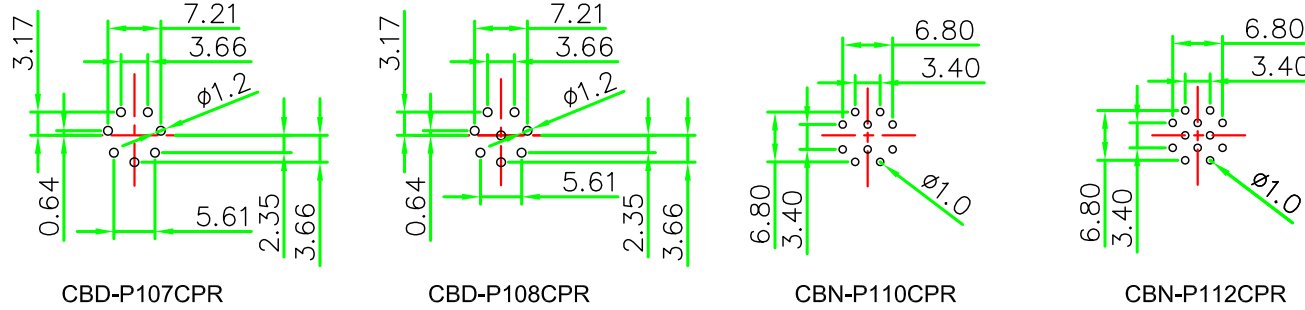
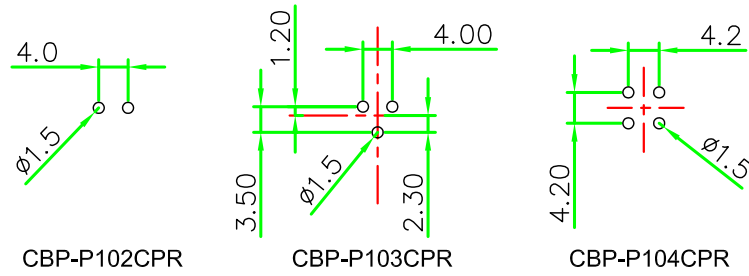

PCB LAYOUT

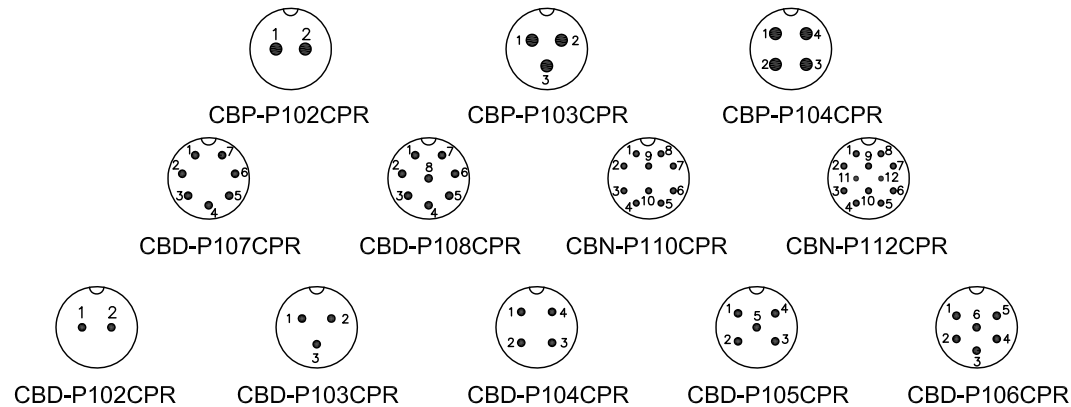

PIN ASSIGNMENT FRONT VIEW

(前視圖)

HOLIN® HTP ASIA TECHNOLOGY CO., LTD. 禾凌科技股份有限公司			
	UNIT: mm	TITLE : Circular B Size Male Connector Male Pin Screw Type Round Flange Rear Panel Mount PCB Pin	
SCALE	1:1	P/N: CBx-P1xxCPR	DR. Patty
UNLESS OTHERWISE SPECIFIED TOLERANCES: .x ± 0.25 .xx ± 0.1 .xxx ± 0.05 ANGLE ± 1°			CH. ERIC
REV. A	SHEET 2/2	DWG.NO: CBx-P1xxCPR	AP.