

RoHS
IP66-68

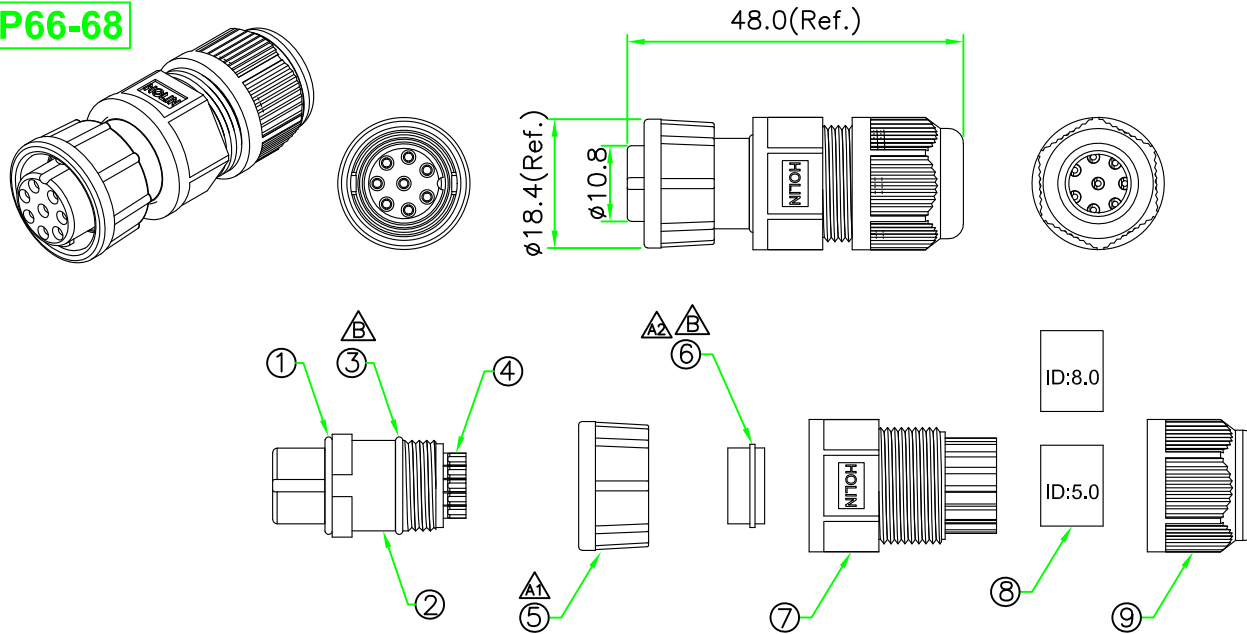

REV.	DESCRIPTION	DATE
A	ISSUE	Sep/04/2008
A1	Change rubber material & lock nut.	Jan/09/2013
A2	ChangeⓈShape And Add Pin Assignment	Jun/17/2014
B	Change O-Ring.(EC-108035)	Dec/04/2019

NOTES:

1. ELECTRICAL CHARACTERISTICS:

CURRENT RATING: 2A / 5A / 10A
CONNECTOR TEMPERATURE RANGE: -40°C TO +105°C
DIELECTRIC WITHSTANDING VOLTAGE:
500V AC FOR ONE MINUTE

2. HOW TO ORDER: CBx-L2xxSA

02 - 2 PIN 07 - 7 PIN
03 - 3 PIN 08 - 8 PIN
04 - 4 PIN 10 - 10 PIN
05 - 5 PIN 12 - 12 PIN
06 - 6 PIN
P - CURRENT RATING 10A
D - CURRENT RATING 5A
N - CURRENT RATING 2A

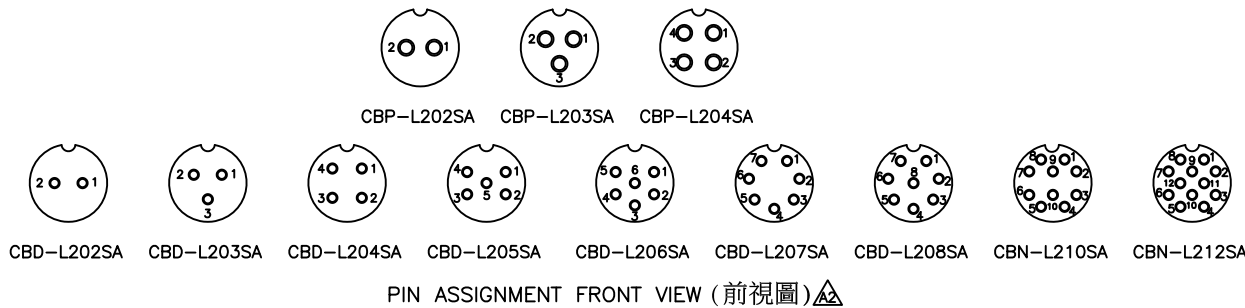

#2 Zipper PE Bag.

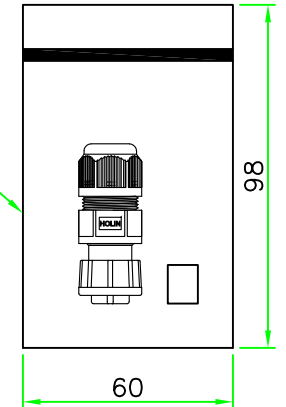

9	CLAMP NUT	Nylon+GF	BLACK	1	
8	TUBE	EPDM.(ID= 5.0 & 8.0mm.)	BLACK	2	
7	HOOD	Nylon	BLACK	1	
6	GASKET	Silicon.Ⓐ	BLACK	1	
5	LOCKING NUT	NYLON+GF	BLACK	1	
4	CONTACT	Brass, Female Pin. 6u"Gold Plated.		N	
3	O-RING	EPDM.Ⓐ	BLACK	1	
2	CONNECTOR	B Size Female Connector Insert, Nylon+GF.		1	
1	O-RING	Viton	BLACK	1	
No.	PART NAME	DESCRIPTION	COLOR	Q'TY	REMARKS

CÉLION
www.portemare-technologie.com

UNIT: mm	TITLE	Circular B Size Lock Type Female Connector Female Pin Field Installable Plug	
SCALE	1:1		
UNLESS OTHERWISE SPECIFIED TOLERANCES: .X ± 0.5 .XX ± 0.25 .XXX ± 0.1 ANGLE ± 1°		P/N:	CBx-L2xxSA
REV.	SHEET	DWG.NO:	CBx-L2xxSA
B	1/1	DR.	SIBYL
		CH.	JAMES
		AP.	

RoHS

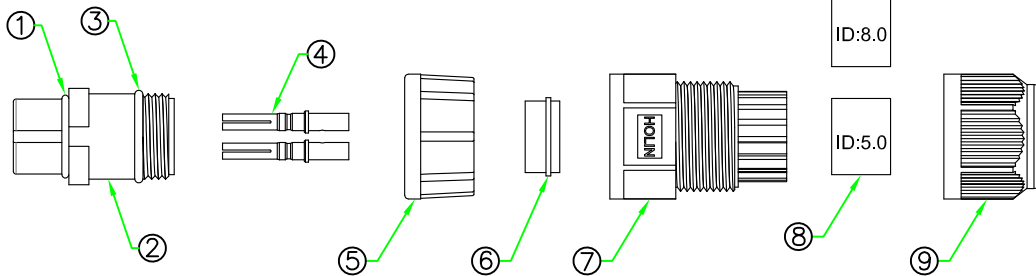
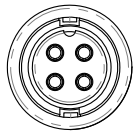
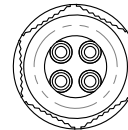
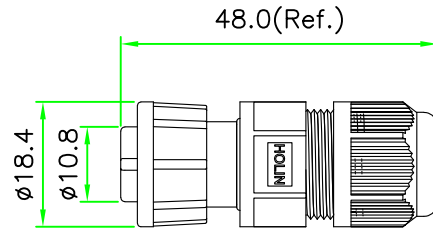
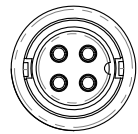
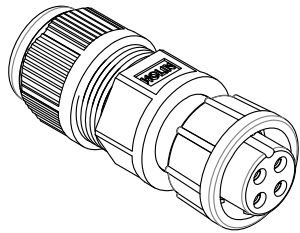

ID:8.0

ID:5.0

#2 Zipper PE Bag.

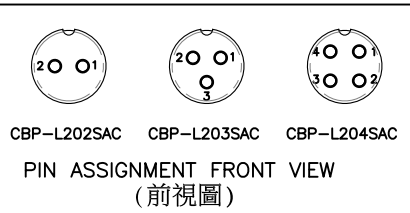
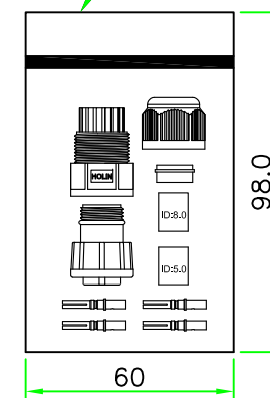

REV.	DESCRIPTION	DATE
A	ISSUE	Sep/26/2020

NOTES:
 1. ELECTRICAL CHARACTERISTICS:
 CURRENT RATING: 10A
 CONNECTOR TEMPERATURE RANGE: -40°C TO +105°C
 DIELECTRIC WITHSTANDING VOLTAGE:
 500V AC FOR ONE MINUTE
 2. HOW TO ORDER: CBP-L2xxSAC
 02 - 2 PIN
 03 - 3 PIN
 04 - 4 PIN
 P - CURRENT RATING 10A

9	CLAMP NUT	NYLON+GF	BLACK	1	
8	TUBE	EPDM, (ID= 5.0 & 8.0mm.)	BLACK	2	
7	HOOD	NYLON	BLACK	1	
6	GASKET	SILICON.	BLACK	1	
5	LOCKING NUT	NYLON+GF	BLACK	1	
4	CONTACT	BRASS ,Female Pin. 6u"Gold Plated.		N	
3	O-RING	EPDM.	BLACK	1	
2	CONNECTOR	B Size Female Connector Insert, NYLON+GF.		1	
1	O-RING	NBR.	BLACK	1	
No.	PART NAME	DESCRIPTION	COLOR	Q'TY	REMARKS

HOLIN® HTP ASIA TECHNOLOGY CO., LTD.
 禾凌科技股份有限公司

UNIT: mm TITLE : Circular B Size Lock Type Female Connector Female Pin Field Installable Plug with Crimp Pin

SCALE 1:1

UNLESS OTHERWISE SPECIFIED TOLERANCES:
 x ±1.0 xx ±0.5
 xxx ±0.25 ANGLE ± 1'

REV. A SHEET 1/1 DWG.NO: CBP-L2xxSAC

P/N: CBP-L2xxSAC DR. James
 CH. ERIC
 AP.