

RoHS

IP66-68

REV.	DESCRIPTION	DATE
A	ISSUE	Oct/30/2015

Ref.

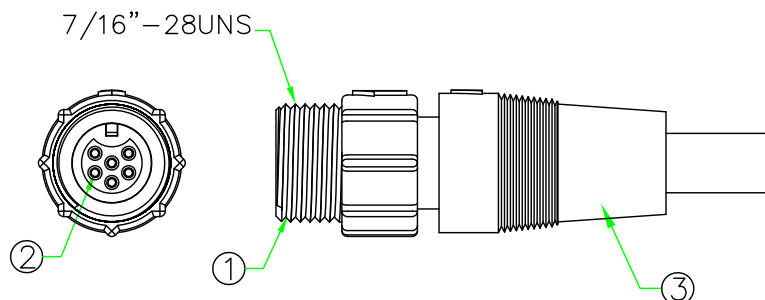
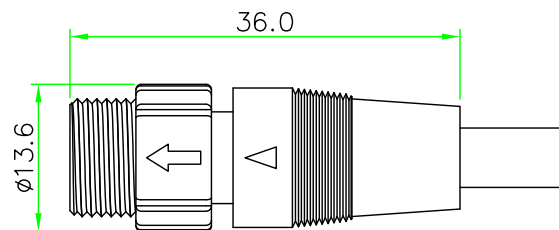
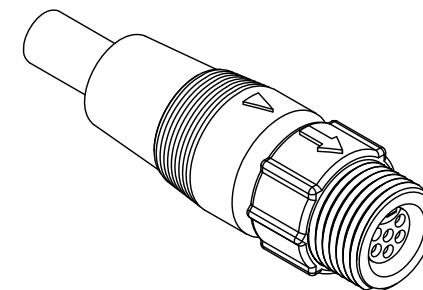

NOTES:

- ELECTRICAL CHARACTERISTICS:
 CURRENT RATING: 2A / 5A
 CONNECTOR TEMPERATURE RANGE: -20°C TO +80°C
 DIELECTRIC WITHSTANDING VOLTAGE:
 500V AC FOR ONE MINUTE
- HOW TO ORDER: CAx-P3xxSN

- 02 - 2 PIN 04 - 4 PIN
- 03 - 3 PIN 05 - 5 PIN
- 06 - 6 PIN
- D - CURRENT RATING 5A
- N - CURRENT RATING 2A

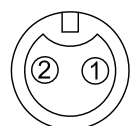

CAD-P302SN

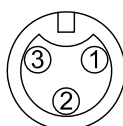

CAD-P303SN

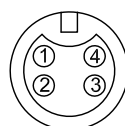

CAN-P304SN

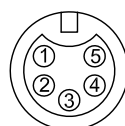

CAN-P305SN

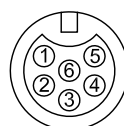

CAN-P306SN

PIN ASSIGNMENT FRONT VIEW
(前視圖)

3	OVERMOLD	PVC or PU.	BLACK	1	
2	CONTACT	Brass, 6u" Gold Plated. Female Pin.		N	
1	CONNECTOR	A Size Male Connector Insert, NYLON+GF.	BLACK	1	
No.	PART NAME	DESCRIPTION	COLOR	Q'TY	REMARKS



	UNIT: mm	TITLE :	Circular A Size Screw Type Male Connector Female Pin Molded Cable
SCALE	1.5:1	P/N:	CAx-P3xxSN
UNLESS OTHERWISE SPECIFIED TOLERANCES: x ±0.5 xx ±0.25 xxx ±0.1 ANGLE ± 1'	REV. A	SHEET 1/1	DWG.NO: CAx-P3xxSN
		DR.	Patty
		CH.	ERIC
		AP.	