

RoHS

IP66~68

REV.	DESCRIPTION	DATE
A	ISSUE	July/05/2007
A1	Update Drawing	Sep/29/2014

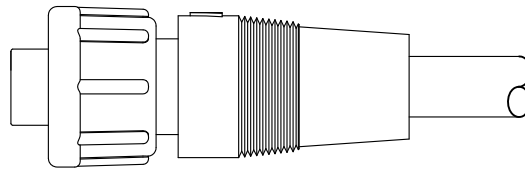
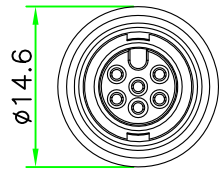
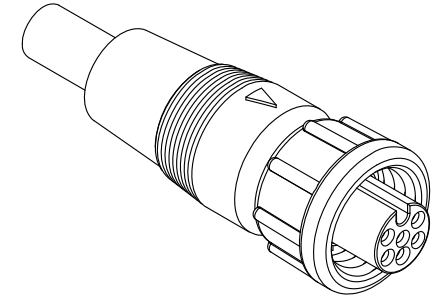
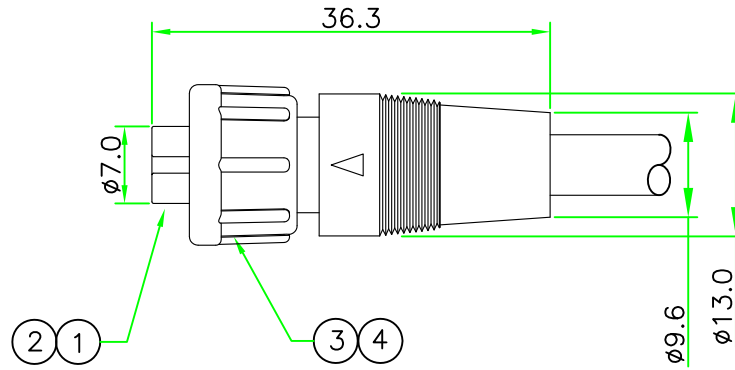

NOTES:

1. ELECTRICAL CHARACTERISTICS:

CURRENT RATING: 2A / 5A

CONNECTOR TEMPERATURE RANGE: -20°C TO +80°C

DIELECTRIC WITHSTANDING VOLTAGE:

500V AC FOR ONE MINUTE

2. HOW TO ORDER: CA<sub>x</sub>-P2<sub>xx</sub>SN

- 02 - 2 PIN    04 - 4 PIN
- 03 - 3 PIN    05 - 5 PIN
- 06 - 6 PIN

- D - CURRENT RATING 5A
- N - CURRENT RATING 2A

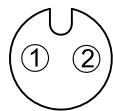

CAD-P202SN

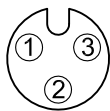

CAD-P203SN

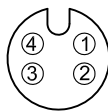

CAN-P204SN

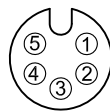

CAN-P205SN

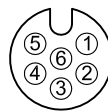



CAN-P206SN

PIN ASSIGNMENT FRONT VIEW

(前視圖)

4	SCREW NUT	NYLON+GF	BLACK	1	
3	O-RING	Silicon.	BLACK	1	
2	CONTACT	Brass , 6 u" Gold Plated .Female Contact.		N	
1	CONNECTOR	A Size Female Connector Insert.NYLON+GF.	BLACK	1	
No.	PART NAME	DESCRIPTION	COLOR	Q'TY	REMARKS

	
	UNIT: mm SCALE: 1 : 1
TITLE : Circular A Size Female Connector Screw Type Molded Cable	
P/N: CA <sub>x</sub> -P2 <sub>xx</sub> SN	DR. Patty CH. ERIC
REV. A1 SHEET 1/1	DWG.NO: CA <sub>x</sub> -P2 <sub>xx</sub> SN AP.



SCALE: 1 : 1

UNLESS OTHERWISE SPECIFIED TOLERANCES:  
 .X ± 0.25 .XX ± 0.1  
 .XXX ± 0.05 ANGLE ± 1°

REV. A1  
 SHEET 1/1

TITLE : Circular A Size Female Connector  
 Screw Type Molded Cable

P/N: CA<sub>x</sub>-P2<sub>xx</sub>SN  
 DR. Patty  
 CH. ERIC

DWG.NO: CA<sub>x</sub>-P2<sub>xx</sub>SN  
 AP.