

REV.	DESCRIPTION	DATE
A	ISSUE	Oct/05/2005
A1	Change length	Mar/05/2015

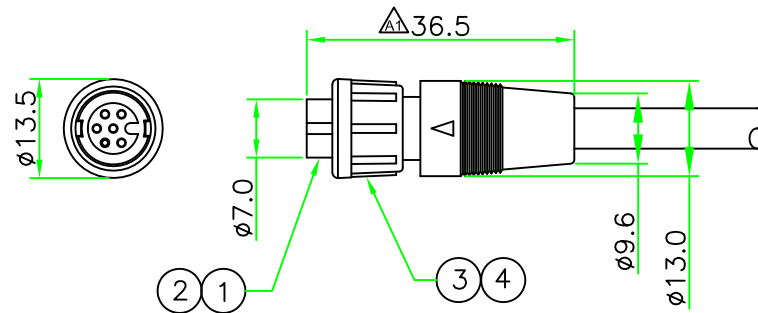

NOTES:

1. ELECTRICAL CHARACTERISTICS:

CURRENT RATING: 2A / 5A

CONNECTOR TEMPERATURE RANGE: -20°C TO +80°C

DIELECTRIC WITHSTANDING VOLTAGE:

500V AC FOR ONE MINUTE

2. HOW TO ORDER: CA<sub>x</sub>-L2<sub>xx</sub>SN

02 - 2 PIN    04 - 4 PIN  
 03 - 3 PIN    05 - 5 PIN  
                   06 - 6 PIN

D - CURRENT RATING 5A  
 N - CURRENT RATING 2A

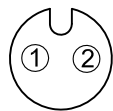

CAD-L202SN

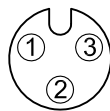

CAD-L203SN

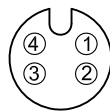

CAN-L204SN

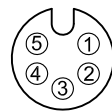

CAN-L205SN

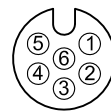



CAN-L206SN

PIN ASSIGNMENT FRONT VIEW

(前視圖)

4	LOCK NUT	NYLON+GF	BLACK	1	
3	O-RING	Silicon.	BLACK	1	
2	CONTACT	Brass , 6 u" Gold Plated .Female Contact.		N	
1	CONNECTOR	A Size Female Connector Insert.NYLON+GF.	BLACK	1	
No.	PART NAME	DESCRIPTION	COLOR	Q'TY	REMARKS

	
	UNIT: mm SCALE: 1 : 1
TITLE : Circular A Size Female Connector Lock Type Molded Cable	
P/N: CA <sub>x</sub> -L2 <sub>xx</sub> SN	
DWG.NO: CA <sub>x</sub> -L2 <sub>xx</sub> SN	
UNLESS OTHERWISE SPECIFIED TOLERANCES: .X ± 0.25 .XX ± 0.1 .XXX ± 0.05 ANGLE ± 1° REV. A1 SHEET 1/1	DR. Patty CH. ERIC AP.